

Automotive 750 V, 800 A Dual Side Cooling Half-Bridge Power Module

VE-Trac™ Dual NVG800A75L4DSC

Product Description

The NVG800A75L4DSC is part of a family of power modules with dual side cooling and compact footprints for Hybrid (HEV) and Electric Vehicle (EV) traction inverter application.

The module consists of two Field Stop 4 (FS4) 750 V Narrow Mesa IGBTs in a half-bridge configuration. The chipset utilizes the new narrow mesa IGBT technology in providing high current density and robust short circuit protection with higher blocking voltage to deliver outstanding performance in EV traction applications.

Features

- Dual-Side Cooling
- Integrated Chip Level Temperature and Current Sensor
- $T_{vj\ max} = 175^{\circ}\text{C}$ for Continuous Operation
- Ultra-low stray inductance
- Low V_{CESAT} and Switching Losses
- Automotive Grade FS4 & Fast Diode Chip Technologies
- 4.2 kV Isolated DBC Substrate
- AEC Qualified and PPAP Capable
- This Device is Pb-Free and is RoHS Compliant

Typical Applications

- Hybrid and Electric Vehicle Traction Inverter
- High Power DC-DC Converter

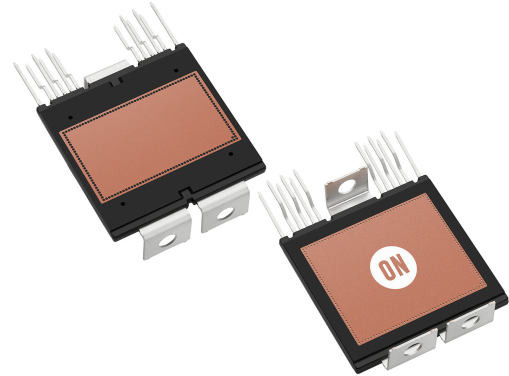

AHPM15-CEA
 CASE 100DD

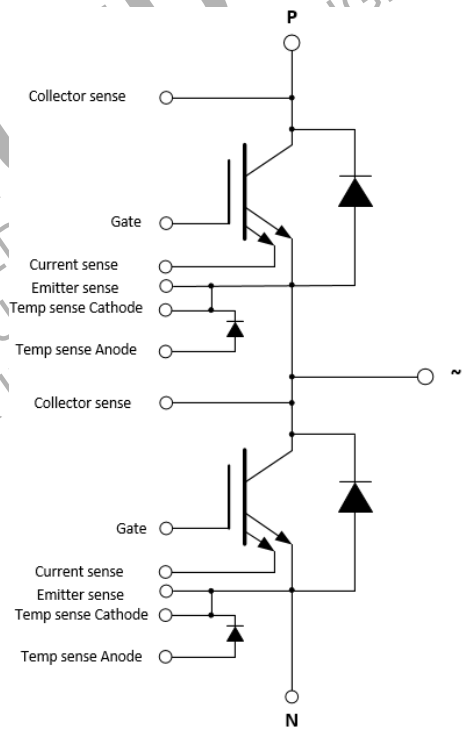

ORDERING INFORMATION

See detailed ordering and shipping information on page 5 of this data sheet.

VE-Trac™ Dual NVG800A75L4DSC

PIN DESCRIPTION

Pin #	Pin	Pin Function Description	Pin Arrangement
1	N	Low Side Emitter	
2	P	High Side Collector	
3	H/S COLLECTOR SENSE	High Side Collector Sense	
4	H/S CURRENT SENSE	High Side Current Sense	
5	H/S EMITTER SENSE	High Side Emitter Sense	
6	H/S GATE	High Side Gate	
7	H/S TEMP SENSE (CATHODE)	High Side Temp sense Diode Cathode	
8	H/S TEMP SENSE (ANODE)	High Side Temp sense Diode Anode	
9	~	Phase Output	
10	L/S CURRENT SENSE	Low Side Current Sense	
11	L/S EMITTER SENSE	Low Side Emitter Sense	
12	L/S GATE	Low Side Gate	
13	L/S TEMP SENSE (CATHODE)	Low Side Temp sense Diode Cathode	
14	L/S TEMP SENSE (ANODE)	Low Side Temp sense Diode Anode	
15	L/S COLLECTOR SENSE	Low Side Collector Sense	

Materials

DBC Substrate: Al₂O₃ isolated substrate, basic isolation, and copper on both sides

Lead Frame: Copper with Tin electro-plating

Flammability Information

All materials present in the power module meet UL flammability rating class 94V-0

MODULE CHARACTERISTICS

Symbol	Parameter	Rating	Unit		
T _{vj}	Continuous Operating Junction Temperature range	-40 to 175	°C		
T _{STG}	Storage Temperature range	-40 to 125	°C		
V _{ISO}	Isolation Voltage, DC, t = 1 s	4200	V		
Creepage	Terminal to Terminal	6.2	mm		
Clearance	Terminal to Terminal	3.4	mm		
CTI	Comparative tracking index	>600	-		
		Min	Typ	Max	
L _{sCE}	Stray Inductance			8	nH
R _{CC'+EE'}	Module lead resistance, terminals – chip			0.15	mΩ
G	Module weight			75	g
M	M4 screws for module terminals			2.2	Nm

VE-Trac™ Dual NVG800A75L4DSC

ABSOLUTE MAXIMUM RATINGS (T_{VJ} = 25°C, Unless Otherwise Specified)

Symbol	Parameter	Rating	Unit
IGBT			
V _{CES}	Collector to Emitter Voltage	750	V
V _{GES}	Gate to Emitter Voltage	±20	V
I _{CN}	Implemented Collector Current	800	A
I _{C nom}	Continuous DC Collector Current, T _{VJmax} = 175°C, T _F = 65°C, ref. heatsink	550 ⁽¹⁾	A
I _{CRM}	Pulsed Collector Current @ V _{GE} = 15 V, t _p = 1 ms	1600	A

Diode

V _{RRM}	Repetitive peak reverse voltage	750	V
I _{FN}	Implemented Forward Current	800	A
I _F	Continuous Forward Current, T _{VJmax} = 175°C, T _F = 65°C, ref. heatsink	420 ⁽¹⁾	A
I _{FRM}	Repetitive Peak Forward Current, t _p = 1 ms	1600	A
I ² t value	Surge current capability, V _R = 0 V, t _p = 10 ms, T _{VJ} = 150°C T _{VJ} = 175°C	20000 18000	A ² s

Stresses exceeding those listed in the Maximum Ratings table may damage the device. If any of these limits are exceeded, device functionality should not be assumed, damage may occur and reliability may be affected.

1. Verified by characterization, not by test.

THERMAL CHARACTERISTICS (Verified by characterization, not by test.)

Symbol	Parameter	Min	Typ	Max	Unit
IGBT.R _{th,J-C}	Effective R _{th} , Junction to Case ⁽²⁾		0.05	0.07	°C/W
IGBT.R _{th,J-F}	Effective R _{th} , Junction to Fluid, λ _{TIM} = 6 W/m-K, F = 660 N 10 L/min, 65°C, 50/50 EGW, Ref. Heatsink		0.14		°C/W
Diode.R _{th,J-C}	Effective R _{th} , Junction to Case ⁽²⁾		0.08	0.10	°C/W
Diode.R _{th,J-F}	Effective R _{th} , Junction to Fluid, λ _{TIM} = 6 W/m-K, F = 660 N 10 L/min, 65°C, 50/50 EGW, Ref. Heatsink		0.21		°C/W

2. For the measurement point of case temperature (T_c), DBC discoloration, picker circle print is allowed, please refer to the VE-Trac Dual assembly guide for additional details about acceptable DBC surface finish.

VE-Trac™ Dual NVG800A75L4DSC

CHARACTERISTICS OF IGBT (Tvj = 25°C, Unless Otherwise Specified)

Parameters	Conditions	Min	Typ	Max	Unit
V _{CESAT}	Collector to Emitter Saturation Voltage (Terminal) V _{GE} = 15 V, I _C = 600 A, T _{VJ} = 25°C T _{VJ} = 150°C T _{VJ} = 175°C V _{GE} = 15 V, I _C = 800 A, T _{VJ} = 25°C T _{VJ} = 150°C T _{VJ} = 175°C	-	1.30 1.42 1.45 1.44 1.64 1.68	1.55	V
I _{CES}	Collector to Emitter Leakage Current V _{GE} = 0, V _{CE} = 750 V T _{VJ} = 25°C T _{VJ} = 175°C	- -	- 8	1 -	mA mA
I _{GES}	Gate – Emitter Leakage Current V _{CE} = 0, V _{GE} = ± 20 V	-	-	400	nA
V _{th}	Threshold Voltage V _{CE} = V _{GE} , I _C = 500 mA	4.6	5.5	6.2	V
Q _G	Total Gate Charge V _{GE} = -8 to 15 V, V _{CE} = 400 V	-	1.9	-	μC
R _{Gint}	Internal gate resistance	-	2	-	Ω
C _{ies}	Input Capacitance V _{CE} = 30 V, V _{GE} = 0 V, f = 1 MHz	-	48	-	nF
C _{oes}	Output Capacitance V _{CE} = 30 V, V _{GE} = 0 V, f = 1 MHz	-	1.37	-	nF
C _{res}	Reverse Transfer Capacitance V _{CE} = 30 V, V _{GE} = 0 V, f = 1 MHz	-	0.15	-	nF
T _{d,on}	Turn on delay, inductive load I _C = 600 A, V _{CE} = 400 V V _{GE} = +15/-8 V R _{g,on} = 4.7 Ω T _{VJ} = 25°C T _{VJ} = 150°C T _{VJ} = 175°C	-	253 283 287	-	ns
T _r	Rise time, inductive load I _C = 600 A, V _{CE} = 400 V V _{GE} = +15/-8 V R _{g,on} = 4.7 Ω T _{VJ} = 25°C T _{VJ} = 150°C T _{VJ} = 175°C	-	94 112 117	-	ns
T _{d,off}	Turn off delay, inductive load I _C = 600 A, V _{CE} = 400 V V _{GE} = +15/-8 V R _{g,off} = 15 Ω T _{VJ} = 25°C T _{VJ} = 150°C T _{VJ} = 175°C	-	760 790 800	-	ns
T _f	Fall time, inductive load I _C = 600 A, V _{CE} = 400 V V _{GE} = +15/-8 V R _{g,off} = 15 Ω T _{VJ} = 25°C T _{VJ} = 150°C T _{VJ} = 175°C	-	95 140 153	-	ns
E _{ON}	Turn-On Switching Loss (including diode reverse recovery loss) I _C = 600 A, V _{CE} = 400 V, V _{GE} = +15/-8 V, L _S = 20 nH, R _{g,on} = 4.7 Ω di/dt (T _{VJ} = 25°C) = 5.13 A/ns di/dt (T _{VJ} = 175°C) = 4.11 A/ns T _{VJ} = 25°C T _{VJ} = 150°C T _{VJ} = 175°C	-	22.41 33.30 36.35	-	mJ
E _{OFF}	Turn-Off Switching Loss I _C = 600 A, V _{CE} = 400 V, V _{GE} = +15/-8 V, L _S = 20 nH, R _{g,off} = 15 Ω dv/dt (T _{VJ} = 25°C) = 2.81 V/ns dv/dt (T _{VJ} = 175°C) = 2.11 V/ns T _{VJ} = 25°C T _{VJ} = 150°C T _{VJ} = 175°C	-	27.22 37.19 39.09	-	mJ
E _{SC}	Minimum Short Circuit Energy Withstand V _{GE} = 15 V, V _{CC} = 400 V T _{VJ} = 25°C T _{VJ} = 175°C	5 7.5			J

VE-Trac™ Dual NVG800A75L4DSC

CHARACTERISTICS OF INVERSE DIODE (T_{VJ} = 25°C, Unless Otherwise Specified)

Parameters		Conditions	Min	Typ	Max	Unit
V _F	Diode Forward Voltage (Terminal)	V _{GE} = 0 V, I _C = 600 A, T _{VJ} = 25°C T _{VJ} = 150°C T _{VJ} = 175°C V _{GE} = 0 V, I _C = 800 A, T _{VJ} = 25°C T _{VJ} = 150°C T _{VJ} = 175°C	-	1.40 1.30 1.30 1.48 1.44 1.42	1.60	V
E _{rr}	Reverse Recovery Energy	I _F = 600 A, V _R = 400 V, V _{GE} = -8 V, R _{g,on} = 4.7 Ω, -di/dt = 3.12 A/ns (175°C) T _{VJ} = 25°C T _{VJ} = 150°C T _{VJ} = 175°C	-	4.09 10.93 11.92	-	mJ
Q _{RR}	Recovered Charge	I _F = 600 A, V _R = 400 V, V _{GE} = -8 V, R _{g,on} = 4.7 Ω, -di/dt = 3.12 A/ns (175°C) T _{VJ} = 25°C T _{VJ} = 150°C T _{VJ} = 175°C	-	18.70 44.48 48.40	-	μC
I _{rr}	Peak Reverse Recovery Current	I _F = 600 A, V _R = 400 V, V _{GE} = -8 V, R _{g,on} = 4.7 Ω, -di/dt = 3.12 A/ns (175°C) T _{VJ} = 25°C T _{VJ} = 150°C T _{VJ} = 175°C	-	248 331 337	-	A

SENSOR CHARACTERISTICS (T_{VJ} = 25°C, Unless Otherwise Specified)

Parameters		Conditions	Min	Typ	Max	Unit
T _{sense}	Temperature sense	I _F = 1 mA, T _{VJ} = -40°C T _{VJ} = 25°C T _{VJ} = 150°C T _{VJ} = 175°C	2.46 ⁽³⁾	2.96 2.54 1.76 1.61	2.60 ⁽³⁾	V
I _{sense}	Current sense	R _{shunt} = 5 Ω I _C = 1600 A I _C = 800 A I _C = 100 A R _{shunt} = 20 Ω I _C = 1600 A I _C = 800 A I _C = 100 A		379 200 43.0 644 351 94.0		mV

3. Measured at chip level

ORDERING INFORMATION

Part Number	Device Marking	Package	Shipping
NVG800A75L4DSC	N875DSC	AHPM15-CEA (Pb-Free)	6 Units / Tube

VE-Trac™ Dual NVG800A75L4DSC

TYPICAL CHARACTERISTICS

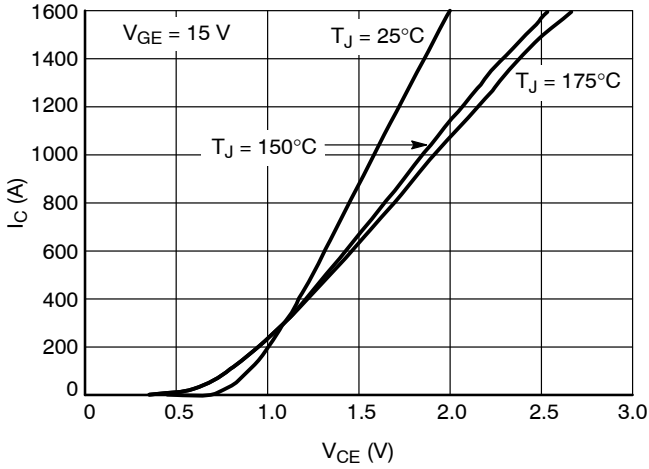

Figure 1. IGBT Output Characteristic

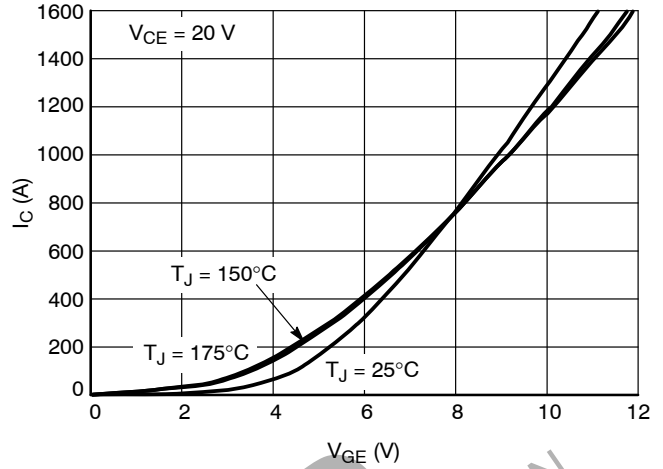

Figure 2. IGBT Output Characteristic

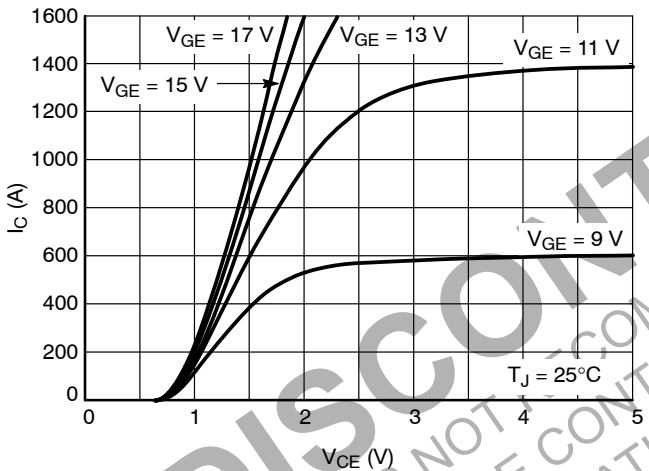

Figure 3. IGBT Output Characteristic

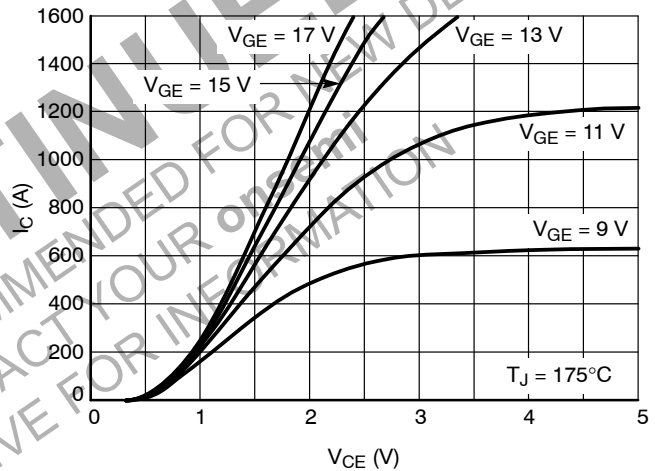

Figure 4. IGBT Output Characteristic

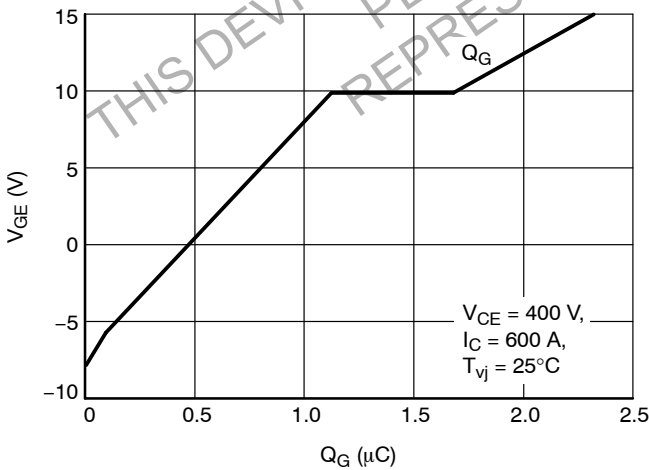

Figure 5. Gate Charge Characteristic

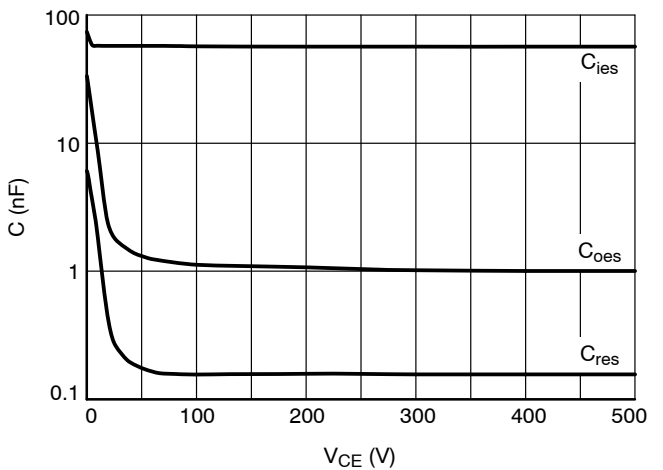

Figure 6. Capacitance Characteristic

VE-Trac™ Dual NVG800A75L4DSC

TYPICAL CHARACTERISTICS

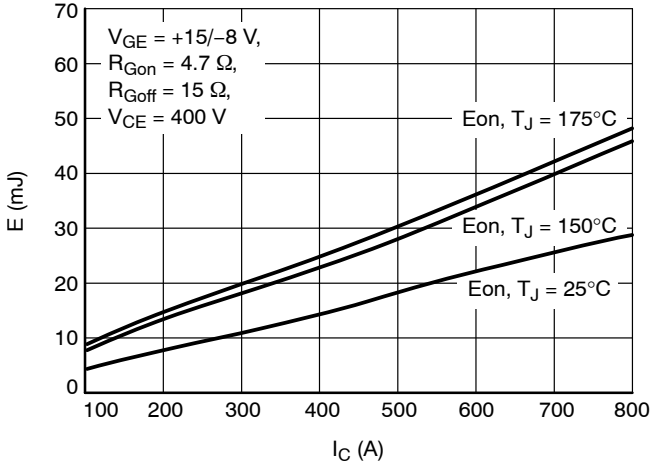

Figure 7. E_{ON} vs. I_C

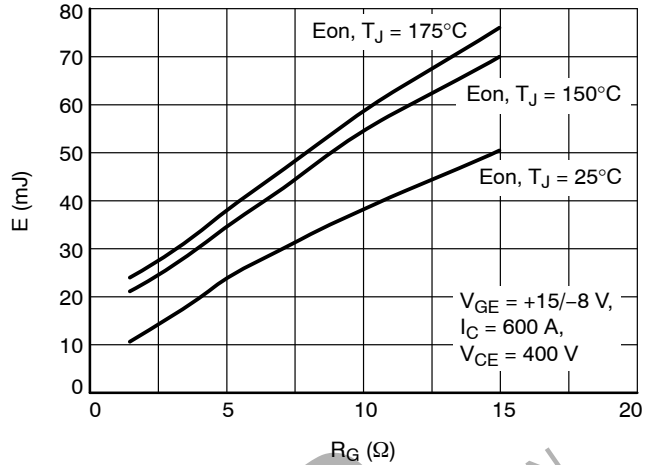

Figure 8. E_{ON} vs. R_G

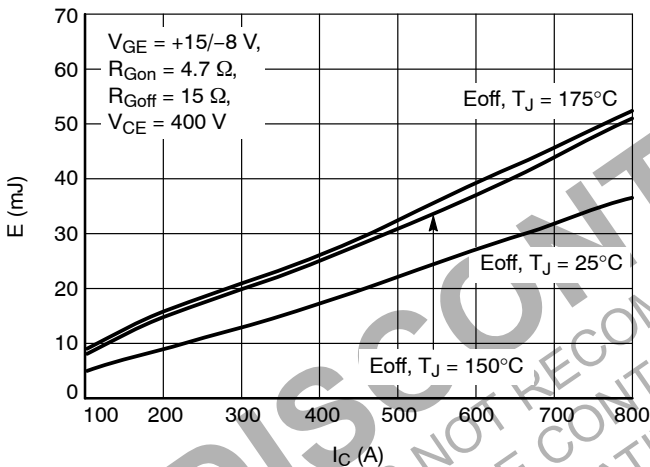

Figure 9. E_{OFF} vs. I_C

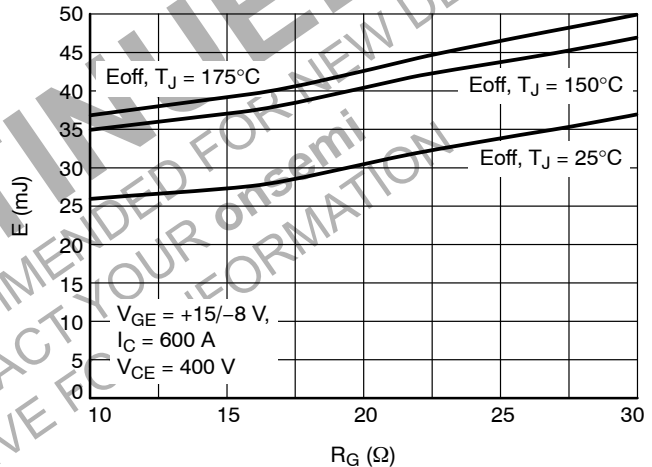

Figure 10. E_{OFF} vs. R_G

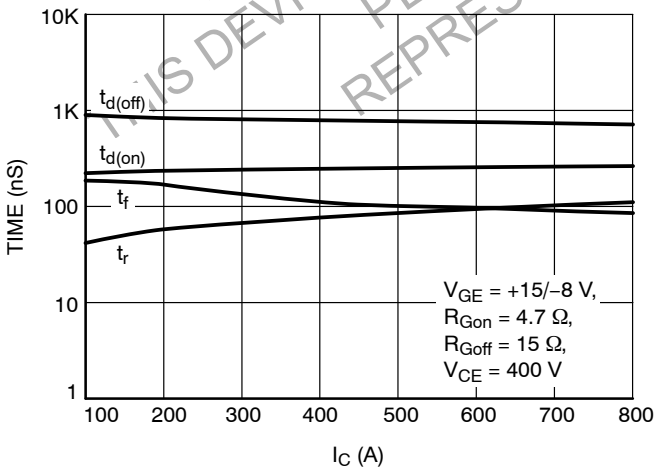

Figure 11. IGBT Switching Times vs. I_C , $T_{VJ} = 25^\circ\text{C}$

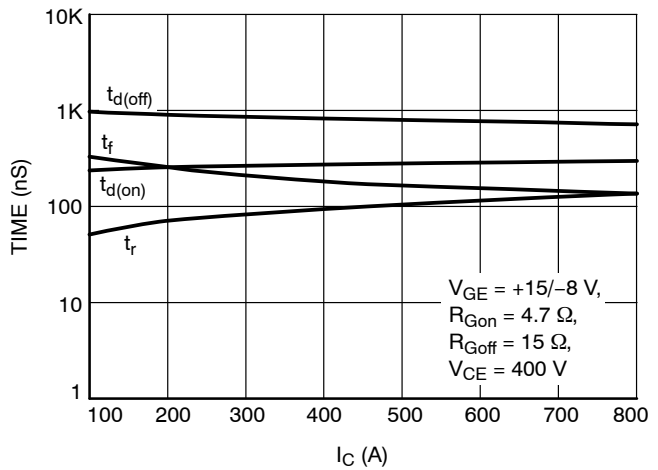

Figure 12. IGBT Switching Times vs. I_C , $T_{VJ} = 175^\circ\text{C}$

TYPICAL CHARACTERISTICS

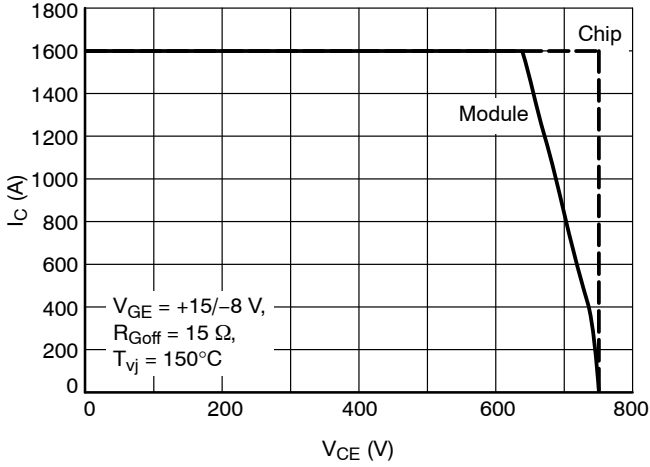

Figure 13. Reverse Bias Safe Operating Area

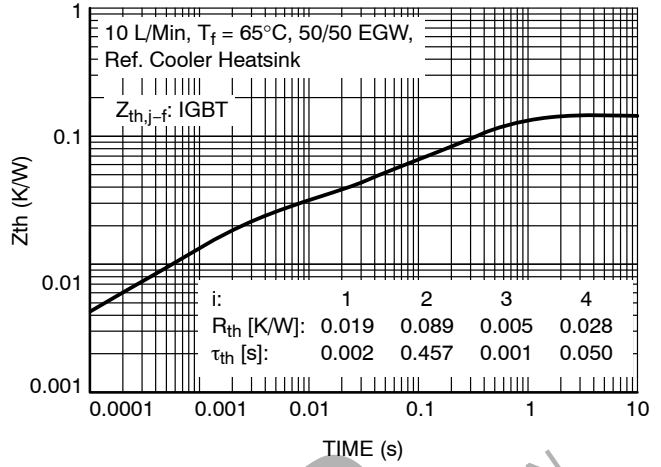

Figure 14. IGBT Transient Thermal Impedance

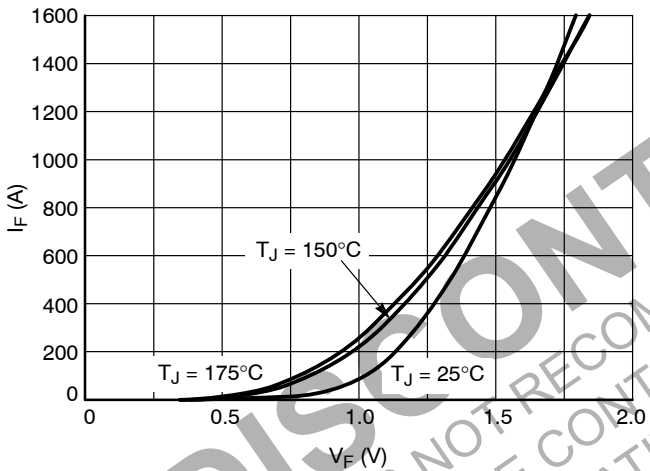

Figure 15. Diode Forward Characteristic

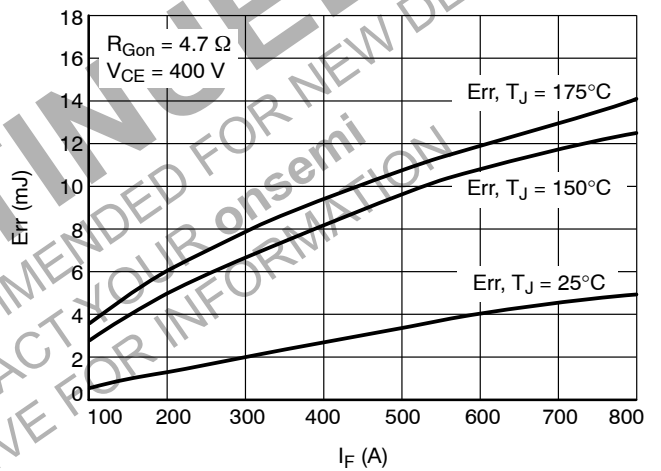

Figure 16. Diode Switching Losses vs. I_F

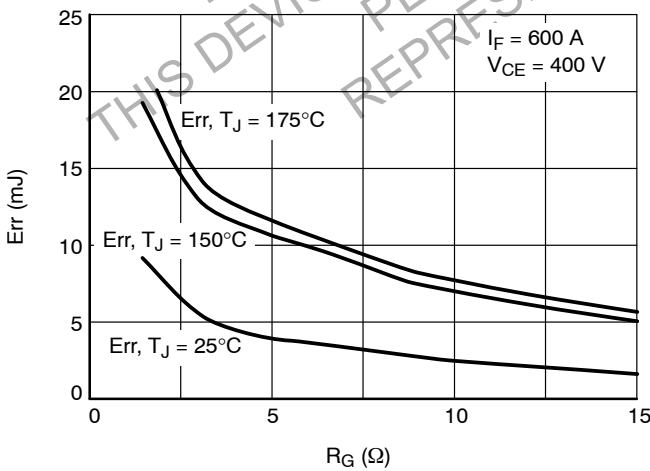

Figure 17. Diode Switching Losses vs. R_G

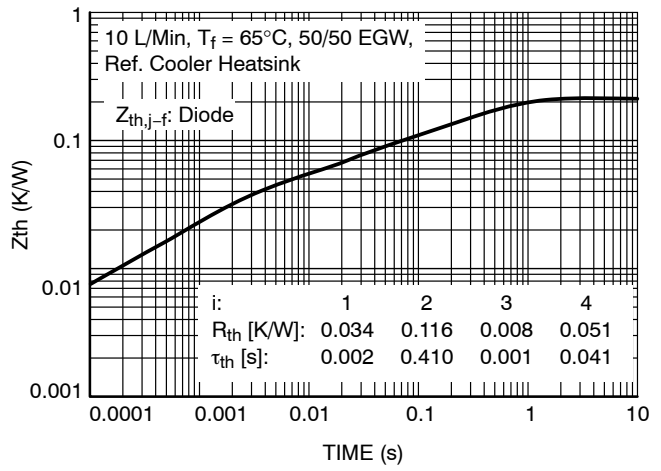

Figure 18. Diode Transient Thermal Impedance

VE-Trac™ Dual NVG800A75L4DSC

TYPICAL CHARACTERISTICS

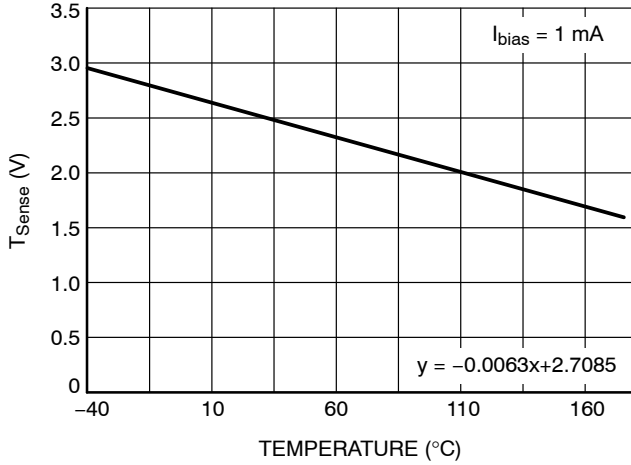

Figure 19. Temperature Sensor Characteristic

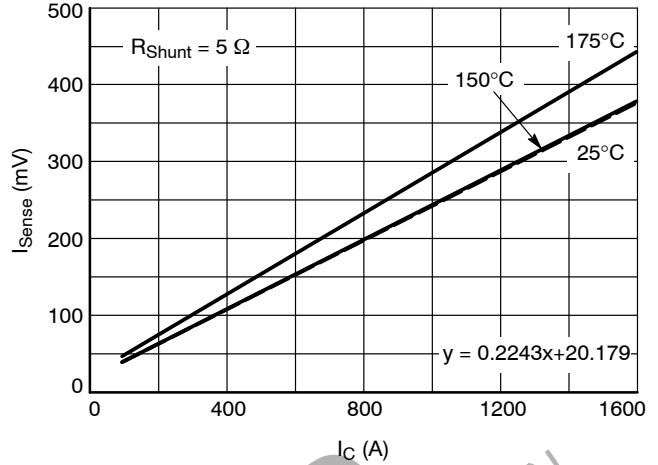

Figure 20. Current Sensor Characteristic

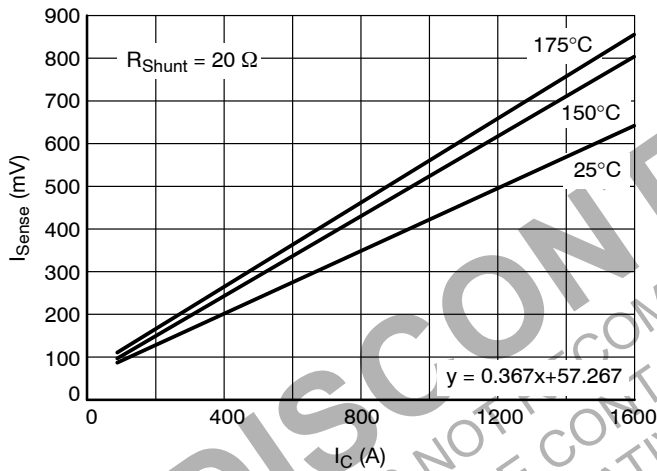

Figure 21. Current Sensor Characteristic

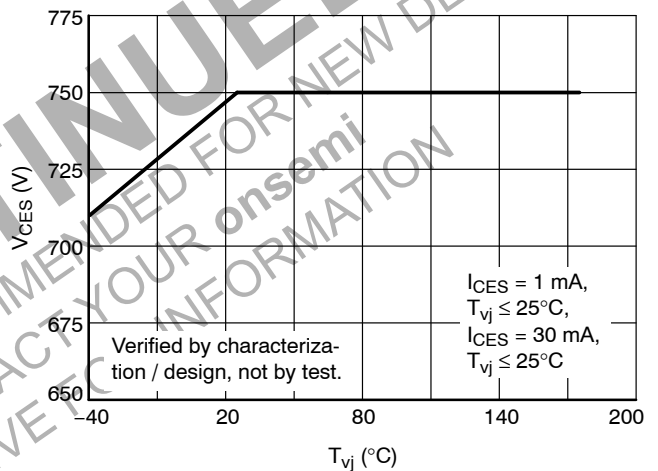

Figure 22. Maximum Allowed V_{CE}

VE-Trac is a trademark of Semiconductor Components Industries, LLC dba "onsemi" or its affiliates and/or subsidiaries in the United States and/or other countries.

MECHANICAL CASE OUTLINE PACKAGE DIMENSIONS



AHPM15-CEA CASE 100DD ISSUE B

DATE 28 SEP 2022

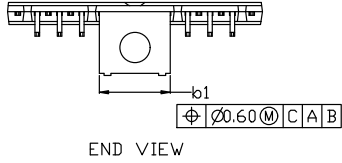

END VIEW

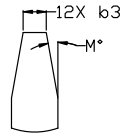

DETAIL B

NOTES:

1. DIMENSIONING AND TOLERANCING PER ASME Y14.5M, 2009.
2. CONTROLLING DIMENSION: MILLIMETERS
3. DIMENSIONS D & E DO NOT INCLUDE MOLD PROTRUSIONS
4. DIMENSIONS b, b1, b2 DO NOT INCLUDE DAMBAR REMAIN.
5. MARKING AREA.
6. E4 IS FROM INNER LEAD TIP TO INNER LEAD TIP DISTANCE.

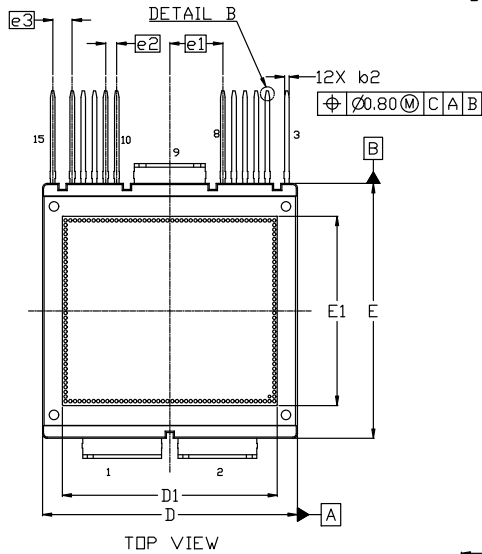

TOP VIEW

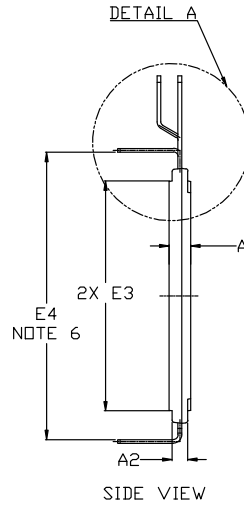

SIDE VIEW

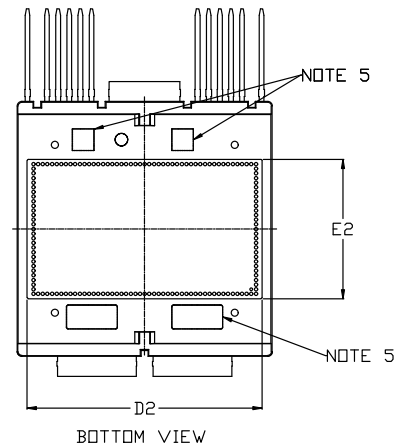

BOTTOM VIEW

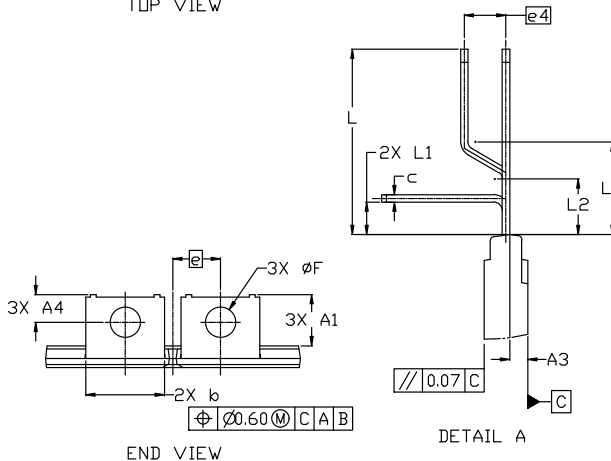

END VIEW

DETAIL A

DIM	MILLIMETERS		
	MIN.	NOM.	MAX.
A	4.65	4.70	4.75
A1	10.75	11.05	11.35
A2	3.20	3.40	3.60
A3	1.60	1.95	2.30
A4	5.70	6.00	6.30
b	16.90	17.00	17.10
b1	15.20	15.30	15.40
b2	0.90	1.00	1.10
b3	0.50 REF		
c	0.70	0.80	0.90
D	54.80	55.00	55.20
D1	46.20	46.50	46.80
D2	50.70	51.00	51.30

DIM	MILLIMETERS		
	MIN.	NOM.	MAX.
E	54.80	55.00	55.20
E1	40.50	40.80	41.10
E2	29.80	30.10	30.40
E3	49.40	49.60	49.80
E4	61.75	62.00	62.25
e	10.30 BSC		
e1	11.45 BSC		
e2	2.40 BSC		
e3	4.20 BSC		
e4	4.50 BSC		
F	6.45	6.50	6.55
L	19.60	20.00	20.40
L1	3.10	3.50	3.90
L2	5.70	6.00	6.30
L3	9.70	10.00	10.30
M	10° REF		

GENERIC MARKING DIAGRAM*



- ZZZ = Assembly Lot Code
- AT = Assembly & Test Site Code
- Y = Year
- WW = Work Week
- XXXX = Specific Device Code
- NNN = Serial Number

*This information is generic. Please refer to device data sheet for actual part marking. Pb-Free indicator, "G" or microdot "µ", may or may not be present. Some products may not follow the Generic Marking.

DOCUMENT NUMBER:	98AON86580G	Electronic versions are uncontrolled except when accessed directly from the Document Repository. Printed versions are uncontrolled except when stamped "CONTROLLED COPY" in red.
DESCRIPTION:	AHPM15-CEA	PAGE 1 OF 1

onsemi and ONSEMI are trademarks of Semiconductor Components Industries, LLC dba onsemi or its subsidiaries in the United States and/or other countries. onsemi reserves the right to make changes without further notice to any products herein. onsemi makes no warranty, representation or guarantee regarding the suitability of its products for any particular purpose, nor does onsemi assume any liability arising out of the application or use of any product or circuit, and specifically disclaims any and all liability, including without limitation special, consequential or incidental damages. onsemi does not convey any license under its patent rights nor the rights of others.

onsemi, **Onsemi**, and other names, marks, and brands are registered and/or common law trademarks of Semiconductor Components Industries, LLC dba "**onsemi**" or its affiliates and/or subsidiaries in the United States and/or other countries. **onsemi** owns the rights to a number of patents, trademarks, copyrights, trade secrets, and other intellectual property. A listing of **onsemi**'s product/patent coverage may be accessed at www.onsemi.com/site/pdf/Patent-Marking.pdf. **onsemi** reserves the right to make changes at any time to any products or information herein, without notice. The information herein is provided "as-is" and **onsemi** makes no warranty, representation or guarantee regarding the accuracy of the information, product features, availability, functionality, or suitability of its products for any particular purpose, nor does **onsemi** assume any liability arising out of the application or use of any product or circuit, and specifically disclaims any and all liability, including without limitation special, consequential or incidental damages. Buyer is responsible for its products and applications using **onsemi** products, including compliance with all laws, regulations and safety requirements or standards, regardless of any support or applications information provided by **onsemi**. "Typical" parameters which may be provided in **onsemi** data sheets and/or specifications can and do vary in different applications and actual performance may vary over time. All operating parameters, including "Typicals" must be validated for each customer application by customer's technical experts. **onsemi** does not convey any license under any of its intellectual property rights nor the rights of others. **onsemi** products are not designed, intended, or authorized for use as a critical component in life support systems or any FDA Class 3 medical devices or medical devices with a same or similar classification in a foreign jurisdiction or any devices intended for implantation in the human body. Should Buyer purchase or use **onsemi** products for any such unintended or unauthorized application, Buyer shall indemnify and hold **onsemi** and its officers, employees, subsidiaries, affiliates, and distributors harmless against all claims, costs, damages, and expenses, and reasonable attorney fees arising out of, directly or indirectly, any claim of personal injury or death associated with such unintended or unauthorized use, even if such claim alleges that **onsemi** was negligent regarding the design or manufacture of the part. **onsemi** is an Equal Opportunity/Affirmative Action Employer. This literature is subject to all applicable copyright laws and is not for resale in any manner.

ADDITIONAL INFORMATION

TECHNICAL PUBLICATIONS:

Technical Library: www.onsemi.com/design/resources/technical-documentation
onsemi Website: www.onsemi.com

ONLINE SUPPORT: www.onsemi.com/support

For additional information, please contact your local Sales Representative at www.onsemi.com/support/sales