

MOSFET - Power, Single N-Channel, Source Down DualCool 33, WDFN9 40 V, 1.3 mΩ, 207 A

NTTFSSCH1D3N04XL

Features

- Excellent Thermal Conduction by Advanced Source-Down Center Gate Dual-Cooling Package Technology (3.3x3.3mm)
- Low $R_{DS(on)}$ to Minimize Conduction Loss
- Low QRR with Soft Recovery to Minimize ERR Loss and Voltage Spike
- Low Q_G and Capacitance to Minimize Driving and Switching Losses
- These Devices are Pb-Free, Halogen Free/BFR Free and are RoHS Compliant

Applications

- High Switching Frequency DC-DC Conversion
- Synchronous Rectifier

MAXIMUM RATINGS ($T_J = 25^\circ\text{C}$ unless otherwise noted)

Parameter	Symbol	Value	Unit
Drain-to-Source Voltage	V_{DSS}	40	V
Gate-to-Source Voltage	DC V_{GS}	± 20	V
Continuous Drain Current	I_D	$T_C = 25^\circ\text{C}$	207
		$T_C = 100^\circ\text{C}$	146
Power Dissipation	$T_C = 25^\circ\text{C}$	P_D	107 W
Pulsed Drain Current	$T_C = 25^\circ\text{C}$, $t_p = 100 \mu\text{s}$	I_{DM}	812 A
Operating Junction and Storage Temperature Range	T_J, T_{stg}	-55 to +175	$^\circ\text{C}$
Continuous Source-Drain Current (Body Diode)	I_S	184	A
Single Pulse Avalanche Energy ($I_{PK} = 52 \text{ A}$)	E_{AS}	135	mJ
Lead Temperature for Soldering Purposes (1/8" from case for 10 s)	T_L	260	$^\circ\text{C}$

Stresses exceeding those listed in the Maximum Ratings table may damage the device. If any of these limits are exceeded, device functionality should not be assumed, damage may occur and reliability may be affected.

1. The entire application environment impacts the thermal resistance values shown, they are not constants and are valid for the particular conditions noted.
2. Surface-mounted on FR4 board using a 1 in² pad size, 1 oz Cu pad.
3. E_{AS} of 135 mJ is based on started $T_J = 25^\circ\text{C}$, $I_{AS} = 52 \text{ A}$, $V_{DD} = 32 \text{ V}$, $V_{GS} = 10 \text{ V}$, 100% avalanche tested.

$V_{(BR)DSS}$	$R_{DS(ON)} \text{ MAX}$	$I_D \text{ MAX}$
40 V	1.3 mΩ @ 10 V	207 A
	1.7 mΩ @ 4.5 V	

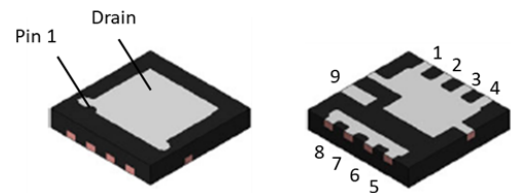
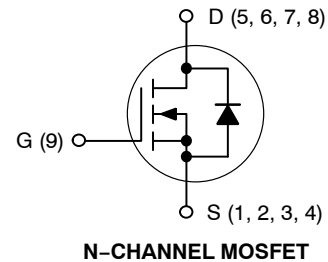

WDFN9
CASE 511BX

MARKING DIAGRAM

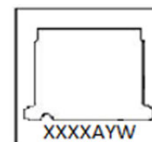

XXXX = Specific Device Code
A = Assembly Location
Y = Year
W = Work Week

ORDERING INFORMATION

See detailed ordering and shipping information on page 3 of this data sheet.

NTTFSSCH1D3N04XL

THERMAL RESISTANCE RATINGS

Parameter	Symbol	Value	Unit
Thermal Resistance, Junction-to-Case (Bottom)	$R_{\theta JC(B)}$	1.4	°C/W
Thermal Resistance, Junction-to-Case (Top)	$R_{\theta JC(T)}$	1.2	
Thermal Resistance, Junction-to-Ambient	$R_{\theta JA}$	60	

ELECTRICAL CHARACTERISTICS ($T_J = 25^\circ\text{C}$ unless otherwise specified)

Parameter	Symbol	Test Condition	Min	Typ	Max	Unit
-----------	--------	----------------	-----	-----	-----	------

OFF CHARACTERISTICS

Drain-to-Source Breakdown Voltage	$V_{(BR)DSS}$	$V_{GS} = 0\text{ V}, I_D = 1\text{ mA}$	40			V
Drain-to-Source Breakdown Voltage Temperature Coefficient	$\Delta V_{(BR)DSS} / \Delta T_J$	$I_D = 1\text{ mA}$, Referenced to 25°C		17		mV/°C
Zero Gate Voltage Drain Current	I_{DSS}	$V_{DS} = 40\text{ V}, T_J = 25^\circ\text{C}$			10	μA
		$V_{DS} = 40\text{ V}, T_J = 125^\circ\text{C}$			100	
Gate-to-Source Leakage Current	I_{GSS}	$V_{DS} = 0\text{ V}, V_{GS} = 20\text{ V}$			100	nA

ON CHARACTERISTICS

Drain-to-Source On Resistance	$R_{DS(ON)}$	$V_{GS} = 10\text{ V}, I_D = 24\text{ A}$		1.0	1.3	mΩ
		$V_{GS} = 6\text{ V}, I_D = 24\text{ A}$		1.1	1.4	
		$V_{GS} = 4.5\text{ V}, I_D = 19\text{ A}$		1.4	1.7	
Gate Threshold Voltage	$V_{GS(TH)}$	$V_{GS} = V_{DS}, I_D = 120\text{ }\mu\text{A}$	1.3		2.2	V
Gate Threshold Voltage Temperature Coefficient	$\Delta V_{GS(TH)} / \Delta T_J$	$V_{GS} = V_{DS}, I_D = 120\text{ }\mu\text{A}$		-5		mV/°C
Forward Transconductance	g_{FS}	$V_{DS} = 5\text{ V}, I_D = 24\text{ A}$		123		S

CHARGES, CAPACITANCES & GATE RESISTANCE

Input Capacitance	C_{ISS}	$V_{GS} = 0\text{ V}, V_{DS} = 20\text{ V}, f = 1\text{ MHz}$		3480		pF
Output Capacitance	C_{OSS}			920		
Reverse Transfer Capacitance	C_{RSS}			32		
Output Charge	Q_{OSS}			35		
Total Gate Charge	$Q_{G(TOT)}$	$V_{GS} = 4.5\text{ V}, V_{DD} = 20\text{ V}; I_D = 24\text{ A}$		21		
		$V_{GS} = 6\text{ V}, V_{DD} = 20\text{ V}; I_D = 24\text{ A}$		28		
Threshold Gate Charge	$Q_{G(TH)}$	$V_{GS} = 10\text{ V}, V_{DD} = 20\text{ V}; I_D = 24\text{ A}$		47		
Gate-to-Source Charge	Q_{GS}			5.7		
Gate-to-Drain Charge	Q_{GD}			10		
Gate Plateau Voltage	V_{GP}			3.4		
Gate Resistance	R_G	$f = 1\text{ MHz}$		2.9		V
				0.6		Ω

SWITCHING CHARACTERISTICS

Turn-On Delay Time	$t_{d(ON)}$	Resistive Load, $V_{GS} = 0/10\text{ V}, V_{DD} = 20\text{ V},$ $I_D = 24\text{ A}, R_G = 2.5\text{ }\Omega$		18		ns
Rise Time	t_r			5		
Turn-Off Delay Time	$t_{d(OFF)}$			43		
Fall Time	t_f			4		

SOURCE-TO-DRAIN DIODE CHARACTERISTICS

Forward Diode Voltage	V_{SD}	$V_{GS} = 0\text{ V}, I_S = 24\text{ A}, T_J = 25^\circ\text{C}$		0.79	1.2	V
		$V_{GS} = 0\text{ V}, I_S = 24\text{ A}, T_J = 125^\circ\text{C}$		0.65		

NTTFSSCH1D3N04XL

ELECTRICAL CHARACTERISTICS (T_J = 25°C unless otherwise specified)

Parameter	Symbol	Test Condition	Min	Typ	Max	Unit
SOURCE-TO-DRAIN DIODE CHARACTERISTICS						
Reverse Recovery Time	t _{RR}	V _{GS} = 0 V, I _S = 24 A, dI/dt = 1000 A/μs, V _{DD} = 20 V		17		ns
Charge Time	t _a			10		
Discharge Time	t _b			7		
Reverse Recovery Charge	Q _{RR}			84		nC

Product parametric performance is indicated in the Electrical Characteristics for the listed test conditions, unless otherwise noted. Product performance may not be indicated by the Electrical Characteristics if operated under different conditions.

ORDERING INFORMATION

Device	Marking	Package	Shipping [†]
NTTFSSCH1D3N04XL	1D3	WDFN9 (Pb-Free)	3000 / Tape & Reel

[†]For information on tape and reel specifications, including part orientation and tape sizes, please refer to our Tape and Reel Packaging Specifications Brochure, BRD8011/D.

NTTFSSCH1D3N04XL

TYPICAL CHARACTERISTICS

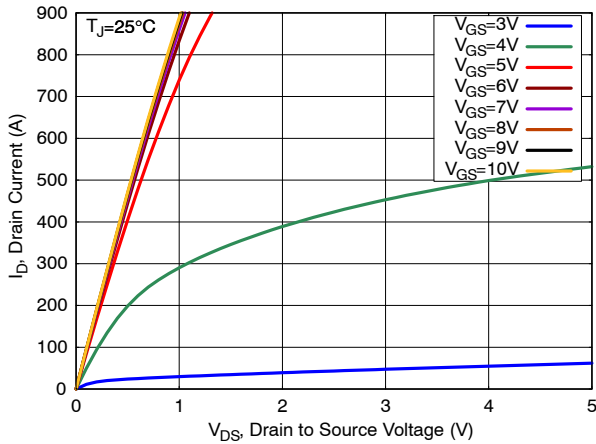

Figure 1. On-Region Characteristics

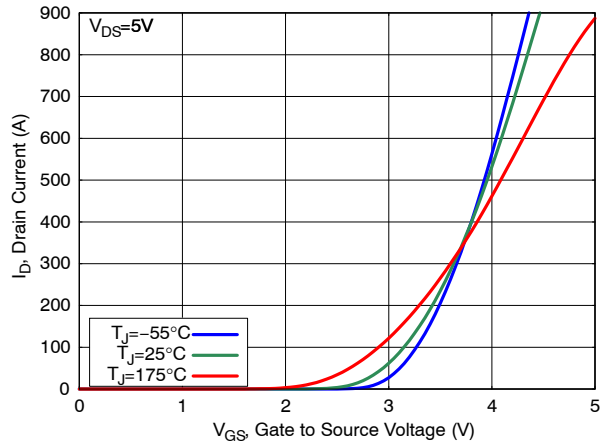

Figure 2. Transfer Characteristics

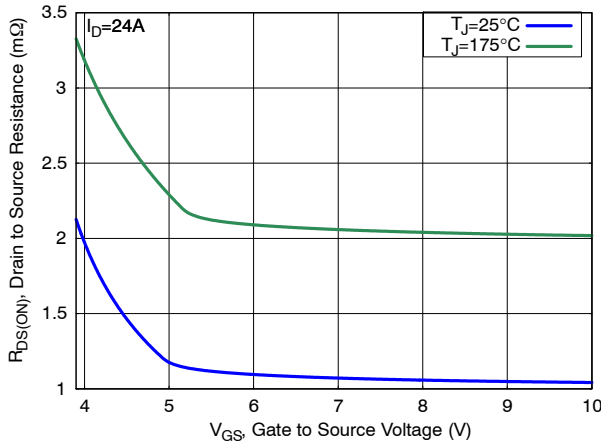

Figure 3. On-Resistance vs. Gate Voltage

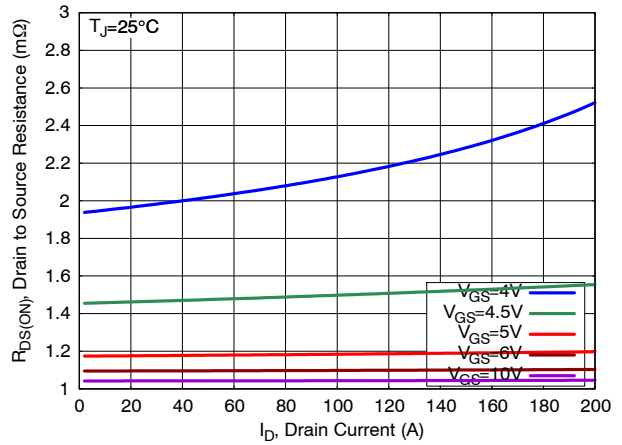

Figure 4. On-Resistance vs. Drain Current

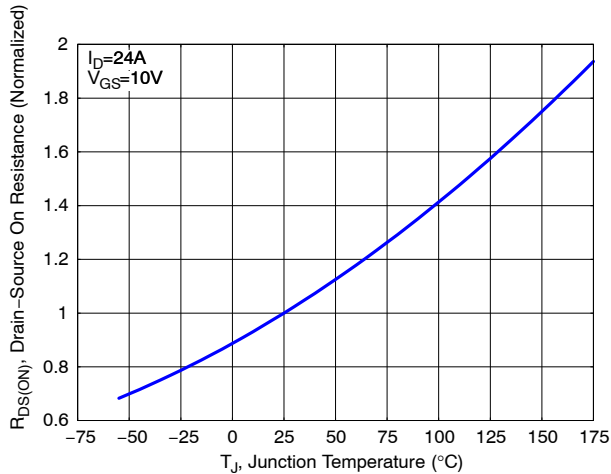

Figure 5. Normalized ON Resistance vs. Junction Temperature

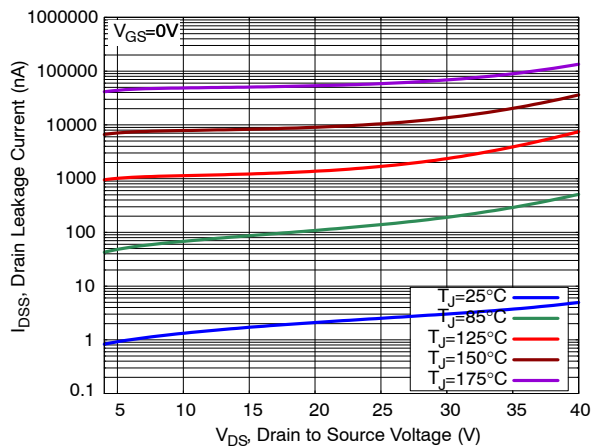

Figure 6. Drain Leakage Current vs. Drain Voltage

NTTFSSCH1D3N04XL

TYPICAL CHARACTERISTICS

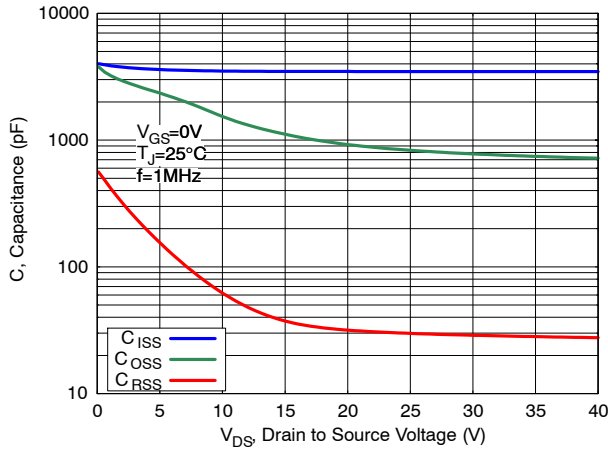

Figure 7. Capacitance Characteristics

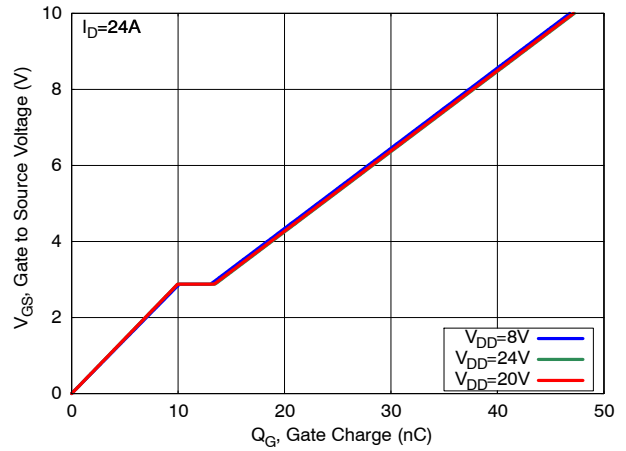

Figure 8. Gate Charge Characteristics

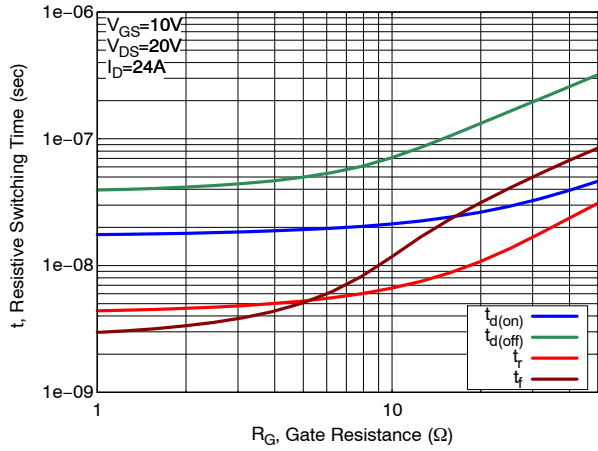

Figure 9. Resistive Switching Time Variation vs. Gate Resistance

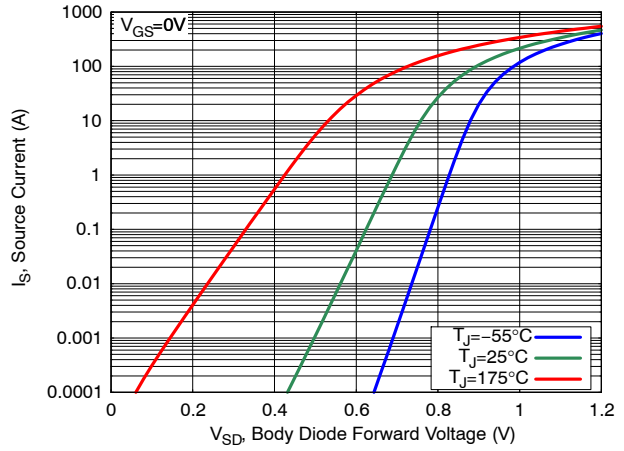

Figure 10. Diode Forward Characteristics

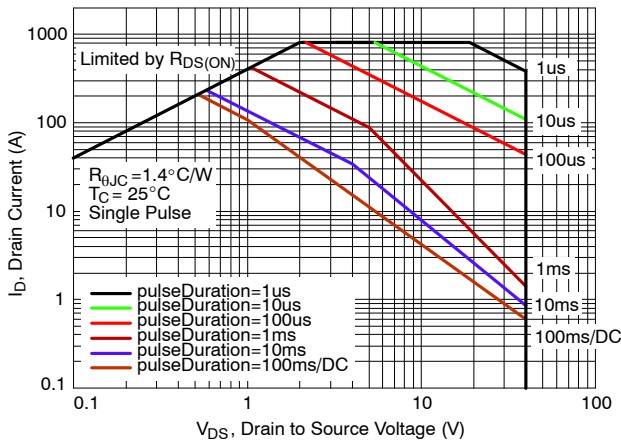

Figure 11. Safe Operating Area (SOA)

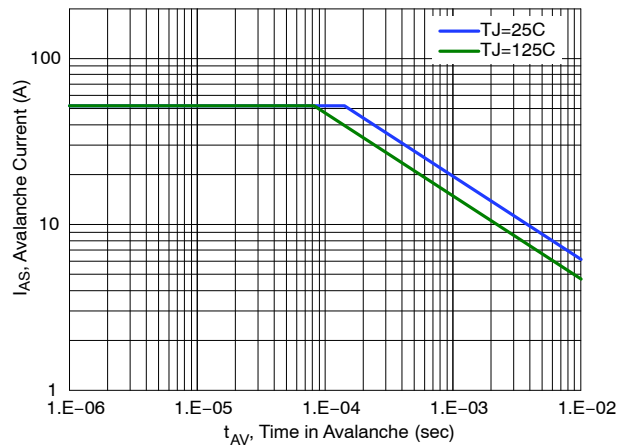

Figure 12. Avalanche Current vs. Pulse Time (UIS)

NTTFSSCH1D3N04XL

TYPICAL CHARACTERISTICS

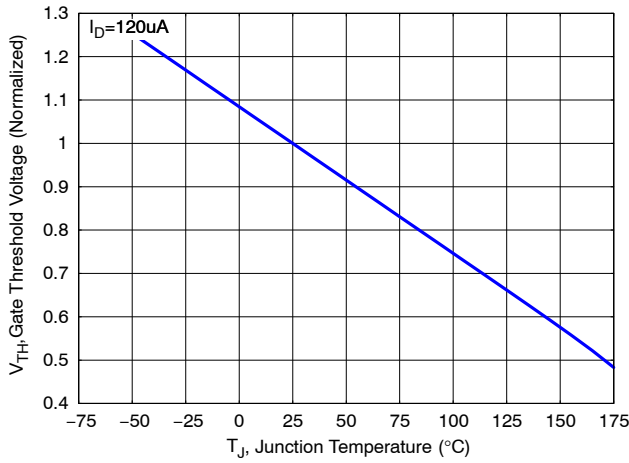

Figure 13. Gate Threshold Voltage vs. Junction Temperature

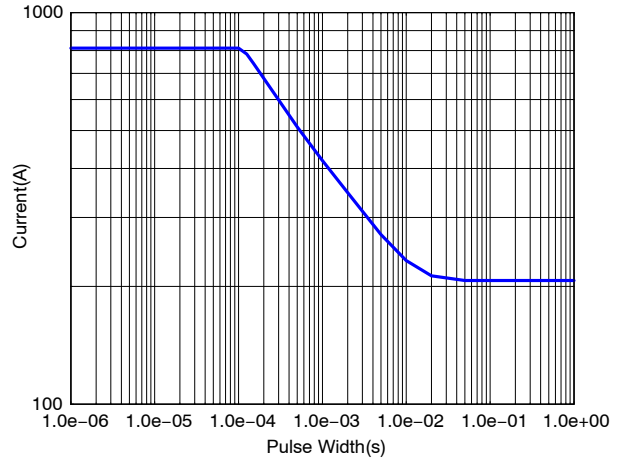

Figure 14. IDM vs. Pulse Width

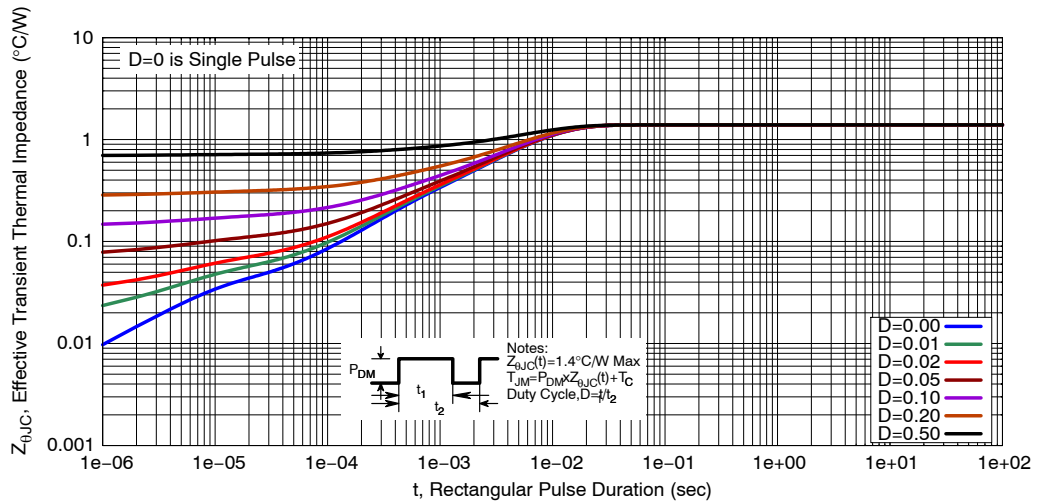
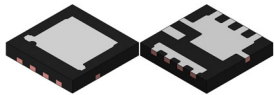
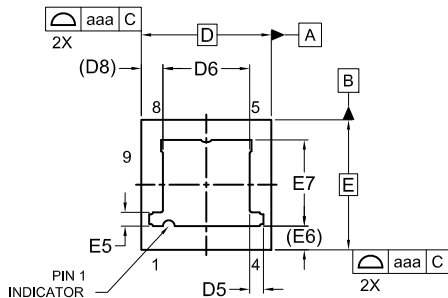

Figure 15. Transient Thermal Response



WDFN9 3.30x3.30x0.58, 0.65P
CASE 511BX
ISSUE B

DATE 13 AUG 2024



TOP VIEW

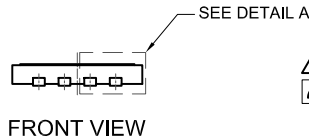

FRONT VIEW

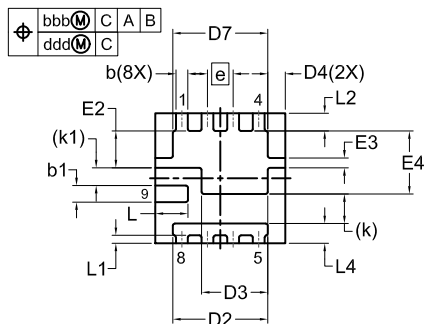

BOTTOM VIEW

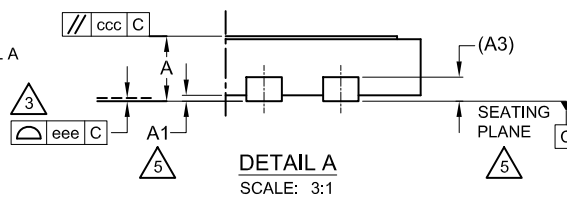

DETAIL A

SCALE: 3:1

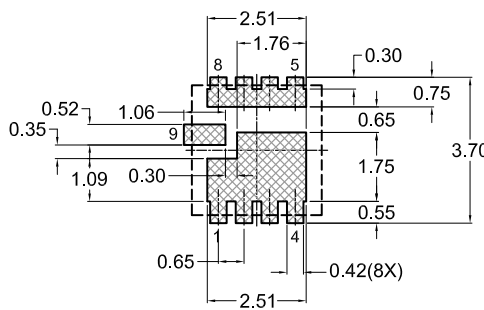

LAND PATTERN RECOMMENDATION

*FOR ADDITIONAL INFORMATION ON OUR PB-FREE STRATEGY AND SOLDERING DETAILS, PLEASE DOWNLOAD THE ONSEMI SOLDERING AND MOUNTING TECHNIQUES REFERENCE MANUAL, SOLDERRM/D.

NOTES:

1. DIMENSIONING AND TOLERANCING PER ASME Y14.5M, 2018.
2. CONTROLLING DIMENSION: MILLIMETERS
3. COPLANARITY APPLIES TO THE EXPOSED PADS AS WELL AS THE TERMINALS.
4. DIMENSIONS D1, D2, E1 AND E2 DO NOT INCLUDE MOLD FLASH. SEATING PLANE IS DEFINED BY THE TERMINALS. "A1" IS DEFINED AS THE DISTANCE FROM THE SEATING PLANE TO THE LOWEST POINT ON THE PACKAGE BODY.

UNIT IN MILLIMETERS			
DIM	MIN	NOM	MAX
A	0.53	0.58	0.63
A1	0.00	-	0.05
A3	0.20 REF		
b	0.25	0.30	0.35
b1	0.37	0.42	0.47
D	3.30 BSC		
D2	2.31	2.41	2.51
D3	1.58	1.68	1.78
D4	0.35	0.45	0.55
D5	0.25	0.35	0.45
D6	2.10	2.20	2.30
D7	2.31	2.41	2.51
D8	0.55 REF		
e	0.65 BSC		
E	3.30 BSC		
E2	0.84	0.94	1.04
E3	0.20	0.25	0.30
E4	1.50	1.60	1.70
E5	0.25	0.35	0.40
E6	0.60 REF		
E7	2.10	2.20	2.30
k	0.75 REF		
k1	0.45 REF		
L	0.73	0.83	0.93
L1	0.10	0.20	0.30
L2	0.35	0.45	0.55
L4	0.40	0.50	0.60
aaa	0.10		
bbb	0.10		
ccc	0.10		
ddd	0.05		
eee	0.08		

GENERIC MARKING DIAGRAM*

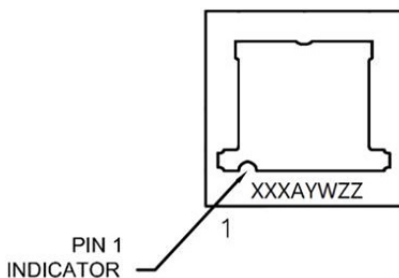

- XXX = Specific Device Code
- A = Assembly Location
- Y = Year
- W = Work Week
- ZZ = Assembly Lot Code

*This information is generic. Please refer to device data sheet for actual part marking. Pb-Free indicator, "G" or microdot "•", may or may not be present. Some products may not follow the Generic Marking.

DOCUMENT NUMBER:	98AON34932H	Electronic versions are uncontrolled except when accessed directly from the Document Repository. Printed versions are uncontrolled except when stamped "CONTROLLED COPY" in red.
DESCRIPTION:	WDFN9 3.30x3.30x0.58, 0.65P	PAGE 1 OF 1

onsemi and ONSEMI are trademarks of Semiconductor Components Industries, LLC dba onsemi or its subsidiaries in the United States and/or other countries. onsemi reserves the right to make changes without further notice to any products herein. onsemi makes no warranty, representation or guarantee regarding the suitability of its products for any particular purpose, nor does onsemi assume any liability arising out of the application or use of any product or circuit, and specifically disclaims any and all liability, including without limitation special, consequential or incidental damages. onsemi does not convey any license under its patent rights nor the rights of others.

onsemi, **Onsemi**, and other names, marks, and brands are registered and/or common law trademarks of Semiconductor Components Industries, LLC dba "**onsemi**" or its affiliates and/or subsidiaries in the United States and/or other countries. **onsemi** owns the rights to a number of patents, trademarks, copyrights, trade secrets, and other intellectual property. A listing of **onsemi**'s product/patent coverage may be accessed at www.onsemi.com/site/pdf/Patent-Marking.pdf. **onsemi** reserves the right to make changes at any time to any products or information herein, without notice. The information herein is provided "as-is" and **onsemi** makes no warranty, representation or guarantee regarding the accuracy of the information, product features, availability, functionality, or suitability of its products for any particular purpose, nor does **onsemi** assume any liability arising out of the application or use of any product or circuit, and specifically disclaims any and all liability, including without limitation special, consequential or incidental damages. Buyer is responsible for its products and applications using **onsemi** products, including compliance with all laws, regulations and safety requirements or standards, regardless of any support or applications information provided by **onsemi**. "Typical" parameters which may be provided in **onsemi** data sheets and/or specifications can and do vary in different applications and actual performance may vary over time. All operating parameters, including "Typicals" must be validated for each customer application by customer's technical experts. **onsemi** does not convey any license under any of its intellectual property rights nor the rights of others. **onsemi** products are not designed, intended, or authorized for use as a critical component in life support systems or any FDA Class 3 medical devices or medical devices with a same or similar classification in a foreign jurisdiction or any devices intended for implantation in the human body. Should Buyer purchase or use **onsemi** products for any such unintended or unauthorized application, Buyer shall indemnify and hold **onsemi** and its officers, employees, subsidiaries, affiliates, and distributors harmless against all claims, costs, damages, and expenses, and reasonable attorney fees arising out of, directly or indirectly, any claim of personal injury or death associated with such unintended or unauthorized use, even if such claim alleges that **onsemi** was negligent regarding the design or manufacture of the part. **onsemi** is an Equal Opportunity/Affirmative Action Employer. This literature is subject to all applicable copyright laws and is not for resale in any manner.

ADDITIONAL INFORMATION

TECHNICAL PUBLICATIONS:

Technical Library: www.onsemi.com/design/resources/technical-documentation
onsemi Website: www.onsemi.com

ONLINE SUPPORT: www.onsemi.com/support

For additional information, please contact your local Sales Representative at www.onsemi.com/support/sales