

MC34268

Voltage Regulator - SCSI-2 Active Terminator, Low Dropout

800 mA, 2.85 V

The MC34268 is a medium current, low dropout positive voltage regulator specifically designed for use in SCSI-2 active termination circuits. This device offers the circuit designer an economical solution for precision voltage regulation, while keeping power losses to a minimum. The regulator consists of a 1.0 V dropout composite PNP/NPN pass transistor, current limiting, and thermal limiting. These devices are packaged in the SOIC-8 and DPAK-3 and SOT-223 surface mount power packages.

Applications include active SCSI-2 terminators and output regulation of switching power supplies.

Features

- 2.85 V Output Voltage for SCSI-2 Active Termination
- 1.0 V Dropout
- Output Current in Excess of 800 mA
- Thermal Protection
- Short Circuit Protection
- Output Trimmed to 1.4% Tolerance
- No Minimum Load Requirement
- Space Saving DPAK-3, SOIC-8, and SOT-223 Surface Mount Power Packages
- Pb-Free Packages available

Simplified Block Diagram

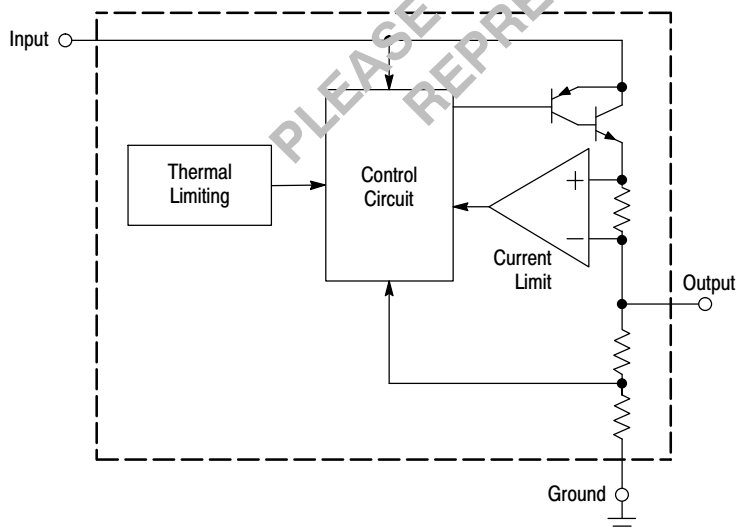

ON Semiconductor®

<http://onsemi.com>

MARKING DIAGRAMS



A = Assembly Location
L = Wafer Lot
Y = Year
W = Work Week

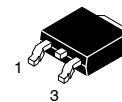
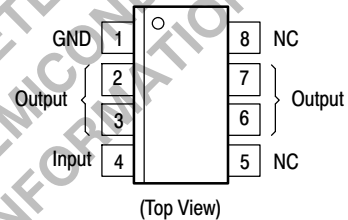

DPAK-3
DT SUFFIX
CASE 369A



SOT-223
ST SUFFIX
CASE 318E

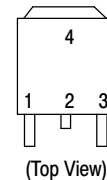
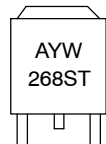

Pin 1. Ground
Pin 2. Output
Pin 3. Input
Pin 4. Output

Heatsink surface (shown as terminal 4 in case outline drawing) is connected to Pin 2.

ORDERING INFORMATION

See detailed ordering and shipping information in the package dimensions section on page 3 of this data sheet.

MAXIMUM RATINGS

Rating	Symbol	Value	Unit
Power Supply Input Voltage	V_{in}	15	V
Power Dissipation and Thermal Characteristics DT Suffix, Plastic Package, Case 369A $T_A = 25^\circ\text{C}$, Derate Above $T_A = 25^\circ\text{C}$ Thermal Resistance, Junction-to-Case Thermal Resistance, Junction-to-Air	P_D $R_{\theta JC}$ $R_{\theta JA}$	Internally Limited 5.0 87	W $^\circ\text{C/W}$ $^\circ\text{C/W}$
D Suffix, Plastic Package, Case 751 $T_A = 25^\circ\text{C}$, Derate Above $T_A = 25^\circ\text{C}$ Thermal Resistance, Junction-to-Case Thermal Resistance, Junction-to-Air	P_D $R_{\theta JC}$ $R_{\theta JA}$	Internally Limited 22 140	W $^\circ\text{C/W}$ $^\circ\text{C/W}$
ST Suffix, Plastic Package, Case 318E $T_A = 25^\circ\text{C}$, Derate Above $T_A = 25^\circ\text{C}$ Thermal Resistance, Junction-to-Case Thermal Resistance, Junction-to-Air	P_D $R_{\theta JC}$ $R_{\theta JA}$	Internally Limited 15 245	W $^\circ\text{C/W}$ $^\circ\text{C/W}$
Operating Ambient Temperature Range	T_A	0 to +125	$^\circ\text{C}$
Maximum Die Junction Temperature	T_J	+150	$^\circ\text{C}$
Storage Temperature	T_{stg}	-55 to +150	$^\circ\text{C}$

Maximum ratings are those values beyond which device damage can occur. Maximum ratings applied to the device are individual stress limit values (not normal operating conditions) and are not valid simultaneously. If these limits are exceeded, device functional operation is not implied, damage may occur and reliability may be affected.

ELECTRICAL CHARACTERISTICS

($V_{in} = 4.25\text{ V}$, $C_O = 10\ \mu\text{F}$, for typical values $T_A = 25^\circ\text{C}$, for maximum values $T_A = 0^\circ\text{C}$ to $+125^\circ\text{C}$ unless otherwise noted.)

Characteristic	Symbol	Min	Typ	Max	Unit
Output Voltage ($T_A = 25^\circ\text{C}$, $I_O = 0\text{ mA}$)	V_O	2.81	2.85	2.89	V
Output Voltage, over Line, Load, and Temperature ($V_{in} = 4.25\text{ V}$ to 15 V , $I_O = 0\text{ mA}$ to 490 mA)		2.76	2.85	2.93	
Line Regulation ($V_{in} = 4.25\text{ V}$ to 15 V , $I_O = 0\text{ mA}$, $T_A = 25^\circ\text{C}$)	Reg_{line}	-	-	0.3	%
Load Regulation ($I_O = 0\text{ mA}$ to 800 mA , $T_A = 25^\circ\text{C}$)	Reg_{load}	-	-	0.5	%
Dropout Voltage ($I_O = 490\text{ mA}$)	$V_{in} - V_O$	-	0.95	1.1	V
Ripple Rejection ($f = 120\text{ Hz}$)	RR	55	-	-	dB
Maximum Output Current ($V_{in} = 4.25\text{ V}$)	$I_{(max)}$	800	-	-	mA
Bias Current ($V_{in} = 4.25\text{ V}$, $I_O = 0\text{ mA}$)	I_B	-	5.0 to 3.0	8.0	mA
Minimum Load Current to maintain Regulation ($V_{in} = 15\text{ V}$)	$I_{L(min)}$	-	-	0	mA

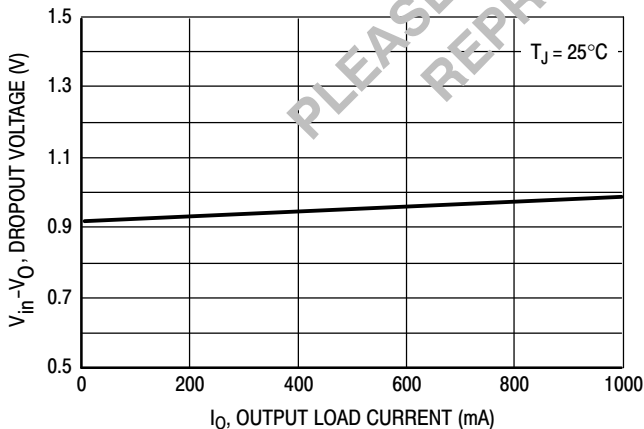

Figure 1. Dropout Voltage versus Output Load Current

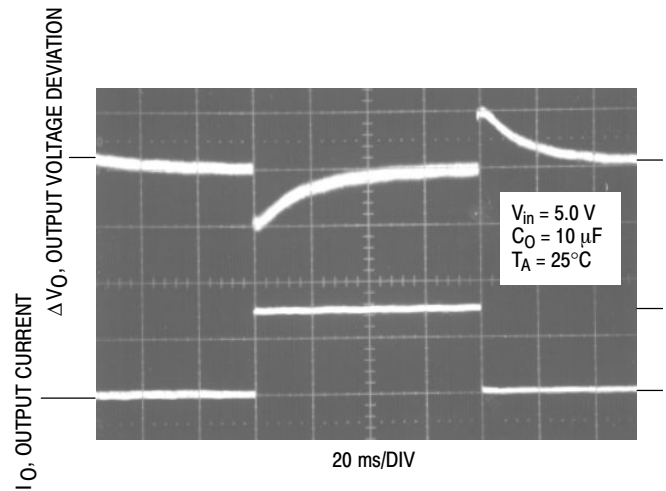

Figure 2. Transient Load Regulation

MC34268

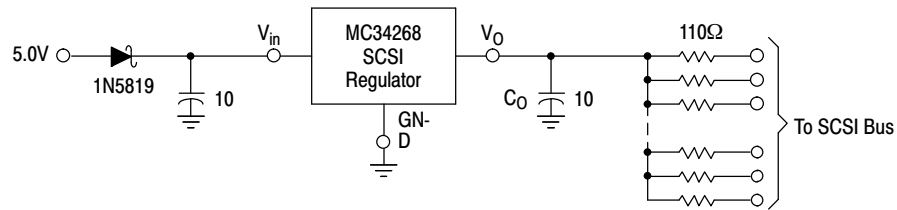

Figure 3. Typical SCSI Application

Figure 3 is a circuit of a typical SCSI terminator application. The MC34268 is designed specifically to provide 2.85 V required to drive a SCSI-2 bus. The output current capability of the regulator is in excess of 800 mA; enough to drive standard SCSI-2, fast SCSI-2, and some wide SCSI-2 applications. The typical dropout voltage is less than 1.0 V, allowing the IC to regulate to input voltages less than 4.0 V. Internal protective features include current and thermal limiting.

The MC34268 requires an external 10 µF capacitor with an ESR of less than 10 Ω for stability over temperature. With economical electrolytic capacitors, cold temperature operation can pose a stability problem. As temperature decreases, the capacitance also decreases and the ESR increases, which could cause the circuit to oscillate. Tantalum capacitors may be a better choice if small size is a requirement. The capacitance and ESR of a tantalum capacitor is more stable over temperature.

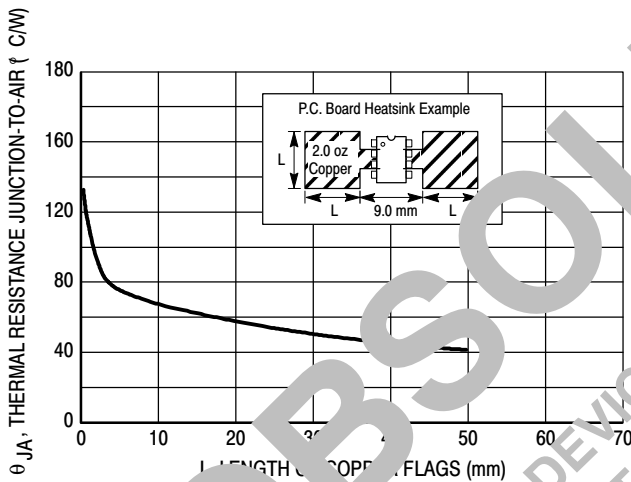

Figure 4. SOIC-8 Thermal Resistance versus P.C.B. Copper Length

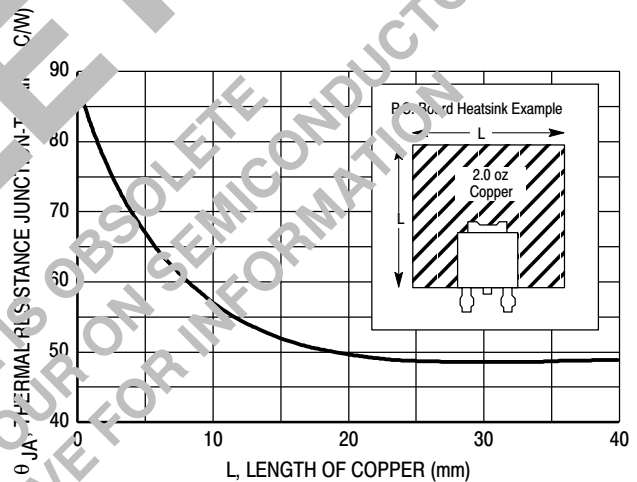

Figure 5. DPAK-3 Thermal Resistance versus P.C.B. Copper Length

ORDERING INFORMATION

Device	Package	Shipping Information†
MC34268D	SOIC-8	98 Units / Rail
MC34268DG	SOIC-8 (Pb-Free)	98 Units / Rail
MC34268DR2	SOIC-8	2500 Units / Tape & Reel
MC34268DR2G	SOIC-8 (Pb-Free)	2500 Units / Tape & Reel
MC34268DT	DPAK-3	75 Units / Rail
MC34268DTG	DPAK-3 (Pb-Free)	75 Units / Rail
MC34268DTRK	DPAK-3	2500 Units / Tape & Reel
MC34268DTRKG	DPAK-3 (Pb-Free)	2500 Units / Tape & Reel
MC34268STT3	SOT-223	4000 Units / Tape & Reel

†For information on tape and reel specifications, including part orientation and tape sizes, please refer to our Tape and Reel Packaging Specifications Brochure, BRD8011/D.

MC34268

PACKAGE DIMENSIONS

SOIC-8
D SUFFIX
CASE 751-07
ISSUE AB

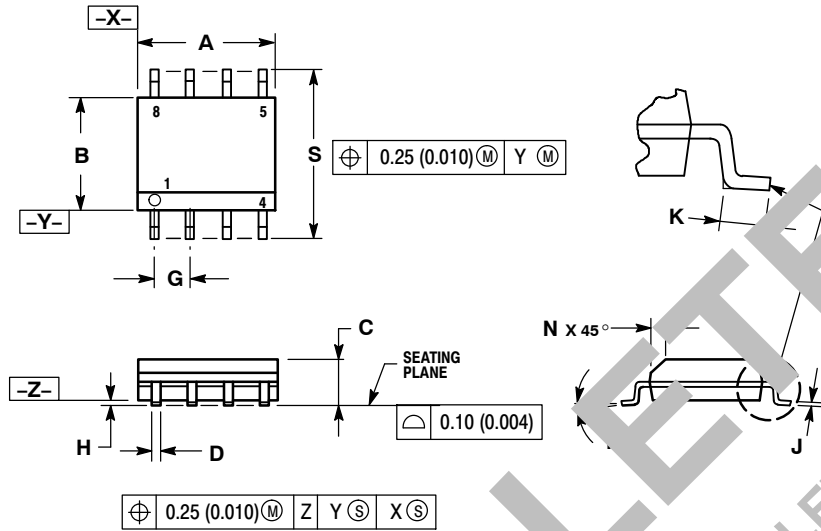

NOTES:

1. DIMENSIONING AND TOLERANCING PER ANSI Y14.5M, 1982.
2. CONTROLLING DIMENSION: MILLIMETER.
3. DIMENSION A AND B DO NOT INCLUDE MOLD PROTRUSION.
4. MAXIMUM MOLD PROTRUSION 0.15 (0.006) PER SIDE.
5. DIMENSION D DOES NOT INCLUDE DAMBAR PROTRUSION. ALLOWABLE DAMBAR PROTRUSION SHALL BE 0.127 (0.005) TOTAL IN EXCESS OF THE D DIMENSION AT MAXIMUM MATERIAL CONDITION.
6. 751-01 THRU 751-06 ARE OBSOLETE. NEW STANDARD IS 751-07.

DIM	MILLIMETERS		INCHES	
	MIN	MAX	MIN	MAX
A	4.80	5.00	0.189	0.197
B	3.80	4.00	0.150	0.157
C	1.35	1.75	0.053	0.069
D	0.33	0.51	0.013	0.020
G	1.27 PSC		0.050 BSC	
H	0.10	0.25	0.004	0.010
J	0.15	0.25	0.007	0.010
K	0.43	1.27	0.016	0.050
M			8°	0°
	0.25	0.20	0.010	0.020
	5.80	2.20	0.228	0.244

SOLDERING FOOTPRINT*

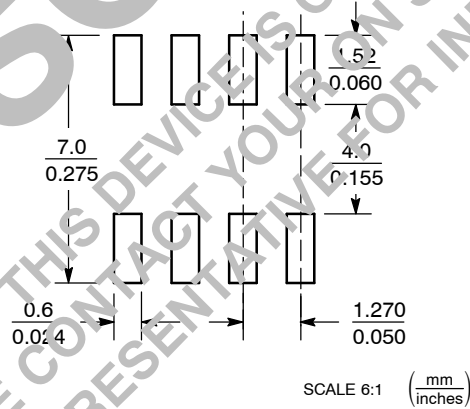

SOIC-8

*For additional information on our Pb-Free strategy and soldering details, please download the ON Semiconductor Soldering and Mounting Techniques Reference Manual, SOLDERRM/D.

MC34268

PACKAGE DIMENSIONS

DK-3
DT SUFFIX
 CASE 369A-13
 ISSUE AB

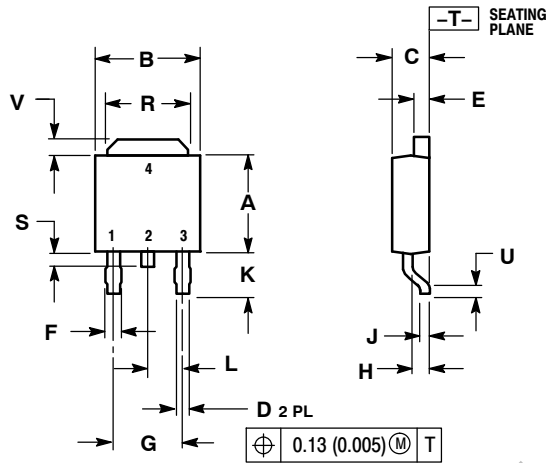

- NOTES:
1. DIMENSIONING AND TOLERANCING PER ANSI Y14.5M, 1982.
 2. CONTROLLING DIMENSION: INCH.

DIM	INCHES		MILLIMETERS	
	MIN	MAX	MIN	MAX
A	0.235	0.250	5.97	6.35
B	0.250	0.265	6.35	6.73
C	0.086	0.094	2.19	2.38
D	0.027	0.035	0.69	0.88
E	0.033	0.040	0.84	1.01
F	0.037	0.047	0.94	1.19
G	0.180 BSC		4.58 BSC	
H	0.034	0.040	0.87	1.01
J	0.018	0.023	0.46	0.58
K	0.102	0.114	2.60	2.89
L	0.090 BSC		2.29 BSC	
R	0.175	0.215	4.5	5.46
S	0.020	0.025	0.51	1.27
U	0.020	---	0.51	---
V	0.030	0.050	0.77	1.27
Z	0.125	---	3.51	---

SOLDERING FOOTPRINT

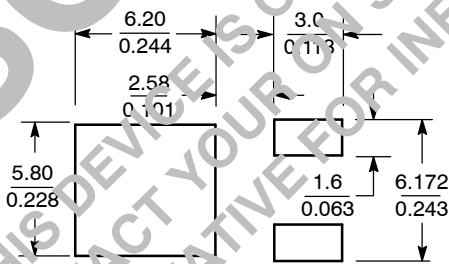

SCALE 3:1 (mm/inches)

DK-3

For additional information on our Pb-Free strategy and soldering details, please download the ON Semiconductor Soldering and Mounting Techniques Reference Manual, SOLDERRM/D.

MC34268

PACKAGE DIMENSIONS

SOT-223
ST SUFFIX
CASE 318E-04
ISSUE K

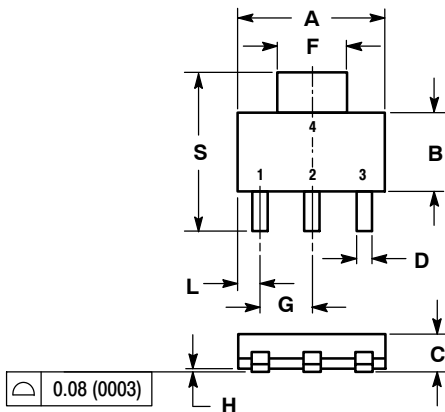

NOTES:

1. DIMENSIONING AND TOLERANCING PER ANSI Y14.5M, 1982.
2. CONTROLLING DIMENSION: INCH.

DIM	INCHES		MILLIMETERS	
	MIN	MAX	MIN	MAX
A	0.249	0.263	6.30	6.70
B	0.130	0.145	3.30	3.70
C	0.060	0.068	1.50	1.75
D	0.024	0.035	0.60	0.89
F	0.115	0.126	2.90	3.20
G	0.087	0.094	2.20	2.40
H	0.0008	0.0040	0.020	0.100
J	0.009	0.014	0.24	0.35
K	0.060	0.078	1.50	2.00
L	0.033	0.041	0.85	1.05
M	0°	10°	0°	2.5°
S	0.264	0.287	6.70	7.30

SOLDERING FOOTPRINT*

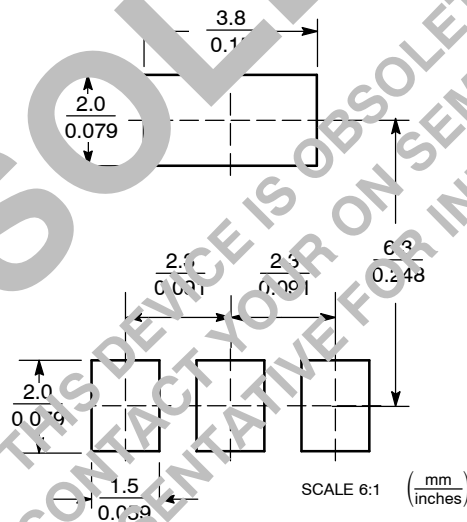

SOT-223

*For additional information on our Pb-Free strategy and soldering details, please download the ON Semiconductor Soldering and Mounting Techniques Reference Manual, SOLDERRM/D.

ON Semiconductor and are registered trademarks of Semiconductor Components Industries, LLC (SCILLC). SCILLC reserves the right to make changes without further notice to any products herein. SCILLC makes no warranty, representation or guarantee regarding the suitability of its products for any particular purpose, nor does SCILLC assume any liability arising out of the application or use of any product or circuit, and specifically disclaims any and all liability, including without limitation special, consequential or incidental damages. "Typical" parameters which may be provided in SCILLC data sheets and/or specifications can and do vary in different applications and actual performance may vary over time. All operating parameters, including "Typicals" must be validated for each customer application by customer's technical experts. SCILLC does not convey any license under its patent rights nor the rights of others. SCILLC products are not designed, intended, or authorized for use as components in systems intended for surgical implant into the body, or other applications intended to support or sustain life, or for any other application in which the failure of the SCILLC product could create a situation where personal injury or death may occur. Should Buyer purchase or use SCILLC products for any such unintended or unauthorized application, Buyer shall indemnify and hold SCILLC and its officers, employees, subsidiaries, affiliates, and distributors harmless against all claims, costs, damages, and expenses, and reasonable attorney fees arising out of, directly or indirectly, any claim of personal injury or death associated with such unintended or unauthorized use, even if such claim alleges that SCILLC was negligent regarding the design or manufacture of the part. SCILLC is an Equal Opportunity/Affirmative Action Employer. This literature is subject to all applicable copyright laws and is not for resale in any manner.

PUBLICATION ORDERING INFORMATION

LITERATURE FULFILLMENT:
Literature Distribution Center for ON Semiconductor
P.O. Box 61312, Phoenix, Arizona 85082-1312 USA
Phone: 480-829-7710 or 800-344-3860 Toll Free USA/Canada
Fax: 480-829-7709 or 800-344-3867 Toll Free USA/Canada
Email: orderlit@onsemi.com

N. American Technical Support: 800-282-9855 Toll Free
USA/Canada

Japan: ON Semiconductor, Japan Customer Focus Center
2-9-1 Kamimeguro, Meguro-ku, Tokyo, Japan 153-0051
Phone: 81-3-5773-3850

ON Semiconductor Website: <http://onsemi.com>

Order Literature: <http://www.onsemi.com/litorder>

For additional information, please contact your local Sales Representative.